

Modular LED signal tower light with built-in terminal

MTG / MTC / MTR Series

MTG realizes customer's various demands by adopting modular design

PRODUCT SPECIFICATION

MTG / MTC / MTR Series

Materials Lens-PC, Housing-ABS, Pole-Al

Ambient operating temperature -30°C to +50°C

Sound volume High-volume buzzer Max. 100dB at 1m
Waterproof buzzer Max. 85dB at 1m

Protection rating

Signal Beacon Terminal type,
Waterproof buzzer module type-IP65
High-volume buzzer module type-Non-Waterproof

Certificates CE, UL

※ UL listed silver housing model is optionally provided

Flashing rate 60-80 flashes/min

Compliant with RoHS directive

- Modular LED steady/flashing type signal tower lights
- 3 unique visual effects are possible as different
 - MTG: Excellent visibility from a distance with the use of a special color diffusing lens
 - MTC: Added a separate color filter lens inside the outer lens to help provide a clear signal
 - MTR: Soft and comfortable signal light emitted through the translucent milky lens
- Can select from size selections of Ø50mm, Ø60mm, and Ø70mm to fit your sophisticated application needs
- Steady/Flashing mode can be selected by using dip switch inside of the LED module
- Push buttons on the terminal help you to realize easy wiring
- Modularized high buzzer module emits intensive buzzer sound
- Sealed design with waterproof buzzer
- MTGA / MTCA / MTRA type offers a nifty integrated lens and cover for a simple aesthetically pleasing product



Each modular color lens can be added without additional tools



MTG / MTC / MTR model uses a special contact structure for stable operation, the lens modules lock into place by rotating the modular structures together. This allows for easy changes to the color arrangement without any tools. Additional modules can be added.

- Terminal type base module**
Terminal type base module can wire power lines and signaling lines separately depending on the installation environment.
- Buzzer module**
High-volume buzzer module: The high-volume buzzer module with a high-output buzzer can deliver a stronger signal than a standard buzzer module. (Buzzer volume: Max. 100dB at 1m).
Waterproof buzzer module: The waterproof buzzer module with a fully enclosed structure can emit a stable buzzer sound (IP Rating: IP65, buzzer volume: Max. 85dB at 1m).
- Integrated cover and lens model**
MTGA / MTCA / MTRA Series the sleek lens cover model is made of one piece for a simple unified look.
- Black and silver applied products (customized type)**
Black or silver products for the body, cover, and buzzer module are customized product.
- M12 connector attached type (customization)**
Built-in M12 connector realizes easy installations and disconnections.
- Can select from a variety of Mounting brackets option to fit your application needs and build environment**
There are a variety of Mounting brackets options available depending on cost and installation requirements.



Modular LED signal tower light with built-in terminal

MTG / MTC / MTR Series

A new concept model that allows users to change and combine individual lens colors without a tool

Cover integrated LED module



It is possible to assemble a product with a different atmosphere from existing products by using a cover lens integrated module in which the cover and the LED module are integrated.

- MGA LED module : Excellent visibility even from a distance by adopting a colored diffuser lens that is integrated with the cover
- MCA LED module : Clear and beautiful signal light by embedding a filter lens in a transparent groove that is integrated with the cover
- MRA LED module : Soft and cozy signal light is emitted by using a milky translucent lens that is integrated with the cover.

Module name	Layout	Product feature
LED module		<ul style="list-style-type: none"> · The LED module adopts a special colored diffused light for excellent visibility. · Customer can select LED function by using the built-in steady/flashing mode switch. · Customer can disassemble and assemble according to the purpose. ※ MTC/MTR module is photographed in a LED steady mode to help customer's understanding.
High-volume buzzer module		<ul style="list-style-type: none"> · The buzzer volume level is up to 100dB. · Intensive buzzer sound is possible by adopting a high-volume buzzer. · Customer can freely disassemble and assemble according to customer's demand.
Waterproof buzzer module		<ul style="list-style-type: none"> · By adopting a completely sealed structure, MTG realizes stable buzzer sound. · Better protection rating which is IP65 in comparison with a built-in buzzer unit. · Customer can freely disassemble and assemble according to customer's demand.

Features when MC / MR module modes are steady/off conditions

- MC/MR module does not display the color of the light source on the module surface when it is turned off (see photo below).



When MC module is off



When MR module is off



When MC module is off



When MR module is off

Can select from a variety of Mounting bracket options to fit your application needs

- You can chose from 9 different kinds of Mounting bracket options.
- The bracket materials vary from steel, aluminum, and polycarbonate
- Please refer to [Tower Light Mounting bracket] on this catalogue for detailed dimensions



Modular LED signal tower light with built-in terminal

MTG / MTC / MTR Series

A model with excellent versatility through the application of various mounting options

Terminal type base module

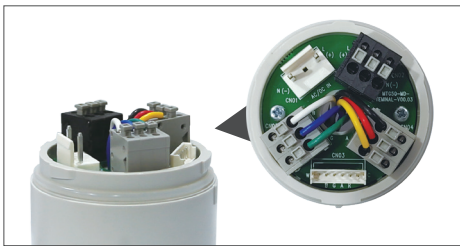

- Constructing a terminal block to release locking on the terminal block type base module enables wiring without using a special tool.
- User directly selects the standard power cable length, color, specifications, and so on and customized wiring is possible.
- Easy wiring by releasing locking with a button.

Module name	Layout	Product feature
Self stand base module		<ul style="list-style-type: none"> · It is used when fixing the product directly to the mounting location without using any other type of Mounting bracket.
Pole type base module		<ul style="list-style-type: none"> · After assembling the pole on the bottom plate of the product, use a separate Mounting bracket to fix the product. · The height of the product can be freely adjusted by changing the pole height. · 9 types of various Mounting brackets can be selected and used according to the installation environment
M12 connector type base module		<ul style="list-style-type: none"> · It is used when fixing the product directly to the mounting location without using any other type of Mounting bracket. · Connect and drive the product using the M12 connector on the bottom plate.

How to assemble modules

- Consumers can purchase the necessary modules and assemble them themselves.
- Detailed specifications and features of the module are introduced in the catalog.
- Module assembly information is included in the assembly guide page.



Pre-assembly unit

- Assemble the functions requested by the consumer and supply it as a finished product.
- The assembly specifications of various types are introduced in the catalog.

How to assemble modules



- ① Assemble so that the I-shaped projections of the module to be assembled coincide with each other.



- ② Lock the upper module by rotating the upper module clockwise so that the triangular protrusion aligns with the I-shaped protrusion of the lower module.

How to dismantle modules



- ① Make sure that the I-shaped projection of the upper module is aligned with the I-shaped projection of the lower module. Rotate the upper module counterclockwise.



- ② Separate the upper module to the upper side.



Modular LED signal tower light with built-in terminal

MTG70 / MTC70 / MTR70 Series

Module Specifications

· Cover

(Units : mm)

Layout	Parts Name	Model No	Color	Common Specifications
	MTG70 Cover	MG70-CV	Ivory	· Material: ABS · Protection ratings with assemble: IP65 · Product size: Ø70 X 14
	MTG70 Cover	MG70-CV-SV	Silver	
	MTG70 Cover	MG70-CV-BK	Black	

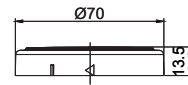

· Buzzer module

(Units : mm)

Layout	Parts Name	Model No	Color	Specification		Volume(dB)	Common Specifications
				Voltage	Current		
	MTG70-High-volume buzzer module	MG70-HBZ-24	Ivory	DC24V	0.080A	Max.100dB	· Material: ABS · Protection ratings with assemble : Non-Waterproof · Product size: Ø70 X 50
	MTG70-High-volume buzzer module	MG70-HBZ-24-SV	Silver	DC24V	0.080A	Max.100dB	
	MTG70-High-volume buzzer module	MG70-HBZ-24-BK	Black	DC24V	0.080A	Max.100dB	
	MTG70-Waterproof buzzer module	MG70-WBZ-24	Ivory	DC24V	0.080A	Max.85dB	· Material: ABS · Protection ratings with assemble: IP65 · Product size: Ø70 X 50
	MTG70-Waterproof buzzer module	MG70-WBZ-24-SV	Silver	DC24V	0.080A	Max.85dB	
	MTG70-Waterproof buzzer module	MG70-WBZ-24-BK	Black	DC24V	0.080A	Max.85dB	

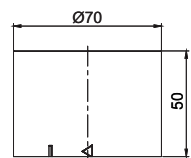
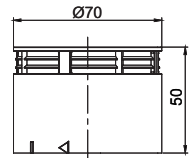





Module Specifications





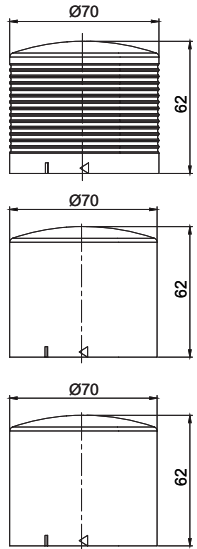







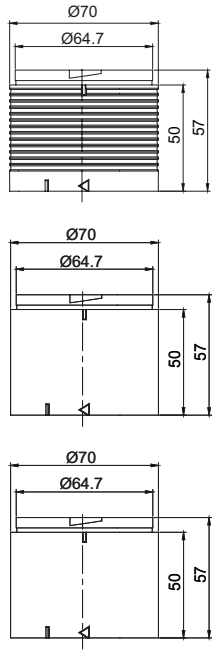

· Cover integrated LED Steady/Flashing module

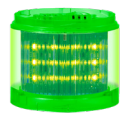
(Units : mm)

Layout			Model No	Color	Specification		Common Specifications
MG	MC	MR			Voltage	Current	
			MGA70-R-24 MCA70-R-24 MRA70-R-24	Red	DC24V	0.050A	<ul style="list-style-type: none"> · Material: PC · Protection ratings with assemble: IP65 · Product size: Ø70 X 62 

· LED Steady/Flashing module

(Units : mm)

Layout			Model No	Color	Specification		Common Specifications
MG	MC	MR			Voltage	Current	
			MG70-R-24 MC70-R-24 MR70-R-24	Red	DC24V	0.050A	<ul style="list-style-type: none"> · Material: PC · Protection ratings with assemble: IP65 · Product size: Ø70 X 57 
			MG70-A-24 MC70-A-24 MR70-A-24	Amber	DC24V	0.050A	
			MG70-G-24 MC70-G-24 MR70-G-24	Green	DC24V	0.050A	
			MG70-B-24 MC70-B-24 MR70-B-24	Blue	DC24V	0.050A	
			MG70-W-24 MC70-W-24 MR70-W-24	White	DC24V	0.050A	

Modular LED signal tower light with built-in terminal

MTG70 / MTC70 / MTR70 Series





· Base module(Pole mount type)

(Units : mm)

Layout	Parts Name	Model No	Color	Specification		Common Specifications
				Voltage	Current	
	MTG70-Pole type base module-DC	MG70-BS-DC	Ivory	DC24V	-	<ul style="list-style-type: none"> · Material: ABS · Protection ratings with assemble: IP65 · Product size: Ø70 X 141
	MTG70-Pole type base module-DC	MG70-BS-DC-SV	Silver	DC24V	-	
	MTG70-Pole type base module-DC	MG70-BS-DC-BK	Black	DC24V	-	
	MTG70-Pole type base module-AC	MG70-BS-AC	Ivory	AC110-220V	0.035A	
	MTG70-Pole type base module-AC	MG70-BS-AC-SV	Silver	AC110-220V	0.035A	
	MTG70-Pole type base module-AC	MG70-BS-AC-BK	Black	AC110-220V	0.035A	

(Units : mm)

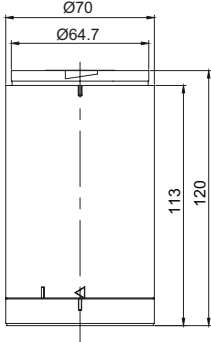
· Base module(Self stand type)

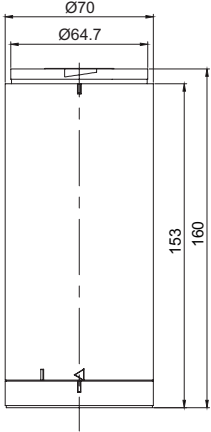





Layout	Parts Name	Model No	Color	Specification		Common Specifications
				Voltage	Current	
	MTG70-Self stand base module-DC	MG70-MBS-DC	Ivory	DC24V	-	· Material: ABS · Protection ratings with assemble: IP65 · Product size: Ø70 X 120
	MTG70-Self stand base module-DC	MG70-MBS-DC-SV	Silver	DC24V	-	
	MTG70-Self stand base module-DC	MG70-MBS-DC-BK	Black	DC24V	-	
	MTG70-Self stand base module-AC	MG70-MBS-AC	Ivory	AC110-220V	0.035A	
	MTG70-Self stand base module-AC	MG70-MBS-AC-SV	Silver	AC110-220V	0.035A	
	MTG70-Self stand base module-AC	MG70-MBS-AC-BK	Black	AC110-220V	0.035A	

Modular LED signal tower light with built-in terminal

MTG70 / MTC70 / MTR70 Series

· Base module(M12 connector type)

(Units : mm)

Layout	Parts Name	Model No	Color	Specification		Common Specifications
				Voltage	Current	
	MTG70-M12 connector type base module-DC	MG70-BS-DC-M12	Ivory	DC24V	-	<ul style="list-style-type: none"> · Material: ABS · Protection ratings with assemble: IP65 · Product size: Ø70 X 119
	MTG70-M12 connector type base module-DC	MG70-BS-DC-M12-SV	Silver	DC24V	-	
	MTG70-M12 connector type base module-DC	MG70-BS-DC-M12-BK	Black	DC24V	-	
	MTG70-M12 connector type base module-AC	MG70-BS-AC-M12	Ivory	AC110-220V	0.035A	<ul style="list-style-type: none"> · Material: ABS · Protection ratings with assemble: IP65 · Product size: Ø70 X 159
	MTG70-M12 connector type base module-AC	MG70-BS-AC-M12-SV	Silver	AC110-220V	0.035A	
	MTG70-M12 connector type base module-AC	MG70-BS-AC-M12-BK	Black	AC110-220V	0.035A	

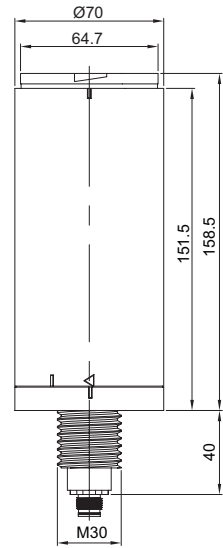
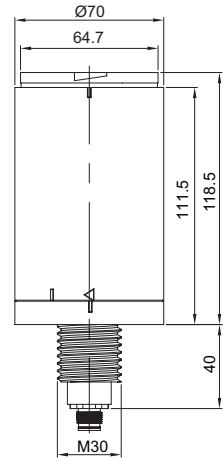









· Pole

(Units : mm)

Layout	Model No	Thread Specifications	Length	Common Specifications
	PE24-100 PE24-250 PE24-400 PE24-700 PE24-800 PE24-1000	M24	100mm 250mm 400mm 700mm 800mm 1000mm	· Pole Outdia: Ø24



· Mounting bracket(Pole mount type)

(Units : mm)

Layout	Parts Name	Model No	Material	Color	Common Specifications
	24mm washers & nuts	SN24-bracket	Steel	-	
	LB24	LB24-bracket	Steel	-	
	LW24	LW24-bracket	PC	Ivory	
	QZ24	QZ24-bracket	PC	Black	-
	SZ24	SZ24-bracket	Al	Silver	
	QL24	QL24-bracket	PC	Black	
	SL24	SL24-bracket	Al	Silver	

· Mounting bracket(Self stand type)

(Units : mm)

Layout	Parts Name	Model No	Material	Color	Common Specifications
	TWS80	TWS45-bracket	Steel	-	
	TWA80	TWA45-bracket	PC	Black	

※ Please refer to [Tower Light Mounting bracket] on this catalogue for detailed dimensions

MTG70 / MTC70 / MTR70 Series

How to configure module

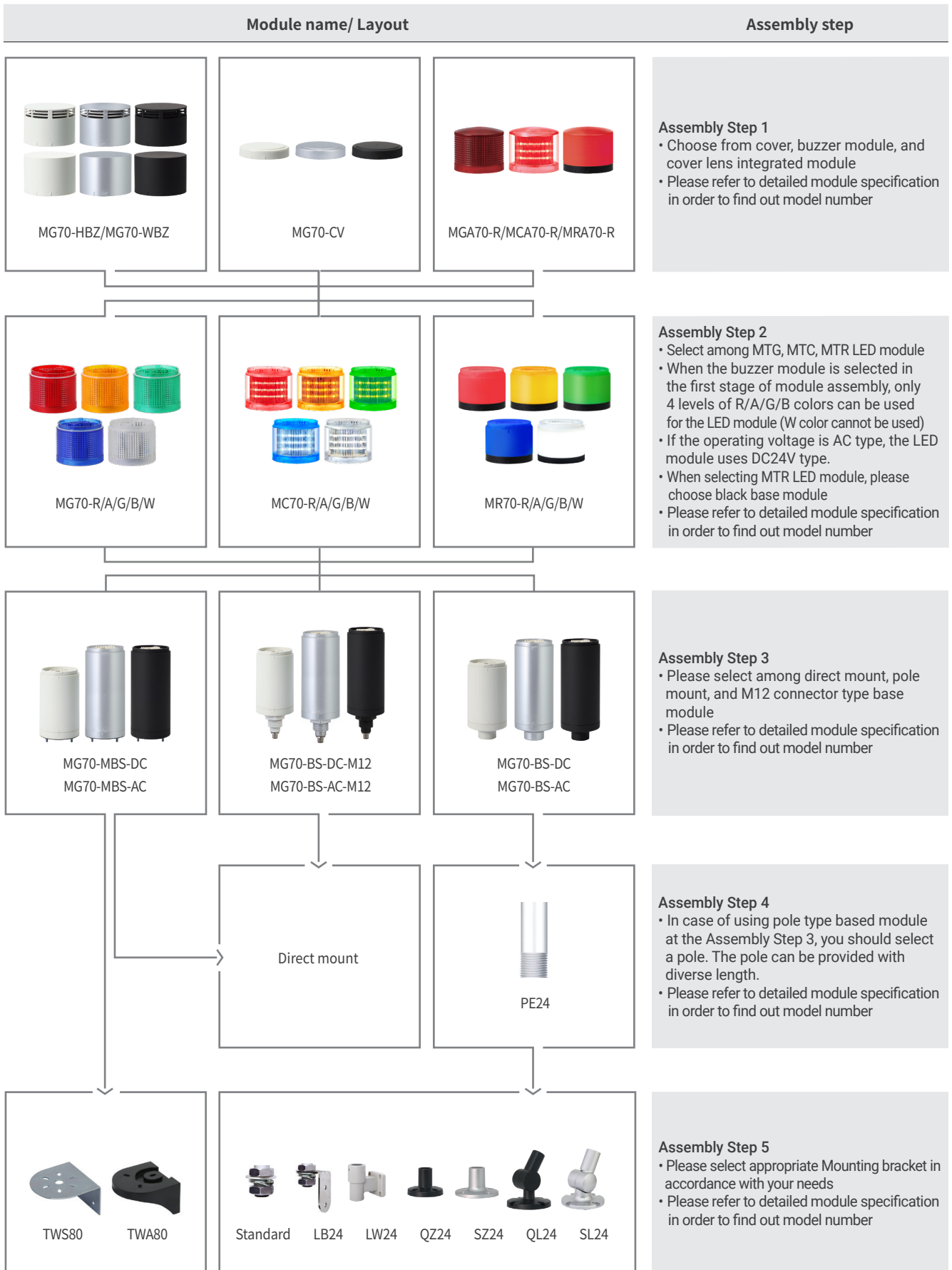

Example of MTG70 module configuration

- You can assemble the product through module combination by referring to the diagram below.
- When a buzzer module (standard buzzer module/high volume buzzer module/waterproof buzzer module) is combined, only 4 LED modules can be assembled (W color module cannot be assembled).

MTG70ML-HBZ-24-4-RAGB		MTG70L-WBZ-110/220-3-RAG-SZ24-SV		MTG70L-24-3-RAG-M12-SV	
Layout	Modules	Layout	Modules	Layout	Modules

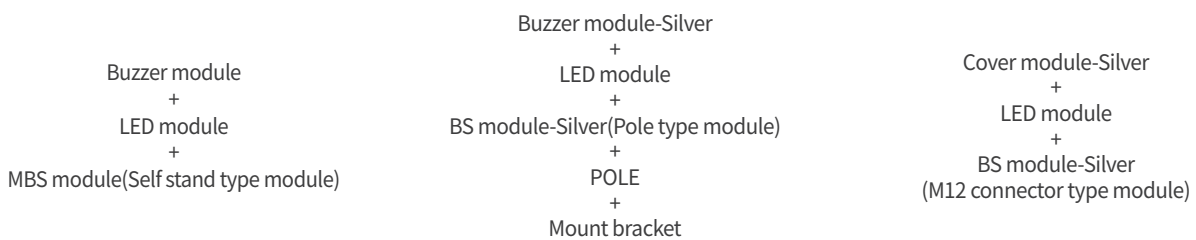
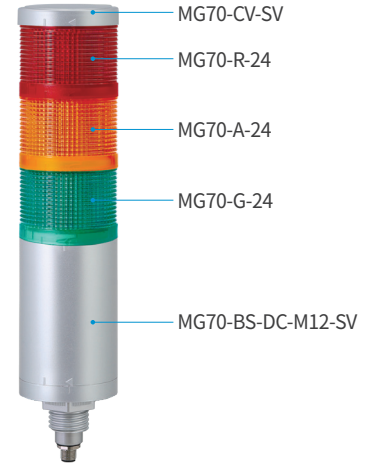
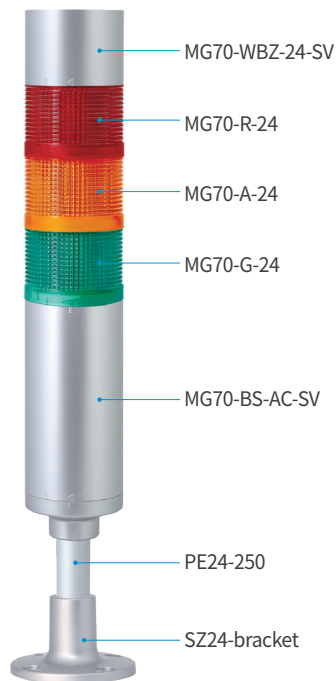
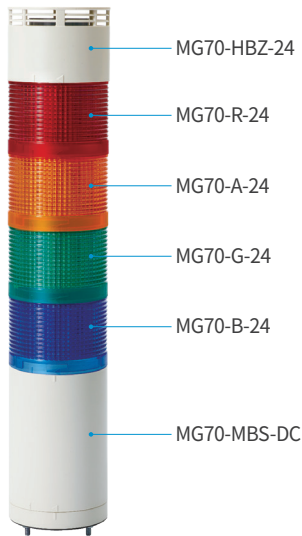

Ordering Specifications

[Upper module]	[LED module]	[Base module]	[Pole]	[Bracket]
MG70-WBZ-24-SV	MG70-R/A/G/B-24	MG70-BS-AC-SV	PE24-250	SZ24
Cover module Buzzer module Cover integrated LED module	● R-Red ● A-Amber ● G-Green ● B-Blue ○ W-White	Pole mount type Self stand type M12 connector type	(Blank)-Self stand type, M12 connector type Pole type	(Blank)-Self stand type, M12 connector type Pole type, Self stand type(Optional)

Modular LED signal tower light with built-in terminal

MTG70 / MTC70 / MTR70 Series

Example of MTC70 module configuration

- You can assemble the product through module combination by referring to the diagram below.
- When a buzzer module (standard buzzer module/high volume buzzer module/waterproof buzzer module) is combined, only 4 LED modules can be assembled (W color module cannot be assembled).

MTC70ML-24-5-RAGBW		MTC70L-110/220-3-RAG-LB24-SV		MTCA70L-110/220-4-RAGB-M12-SV	
Layout	Modules	Layout	Modules	Layout	Modules

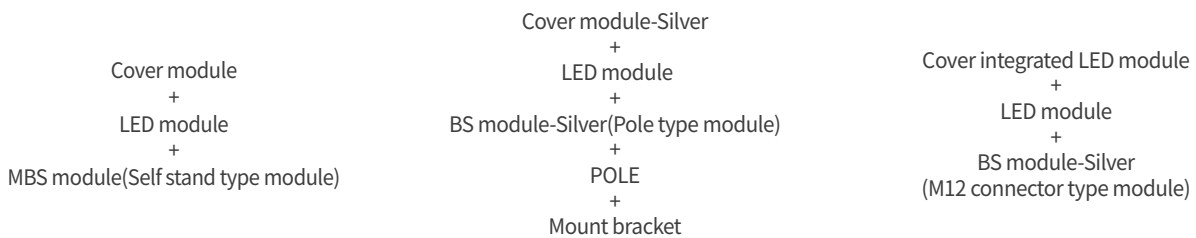
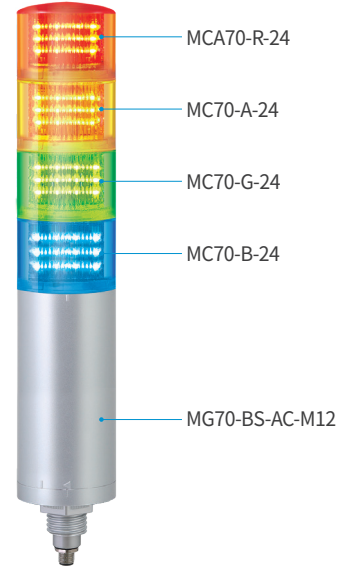
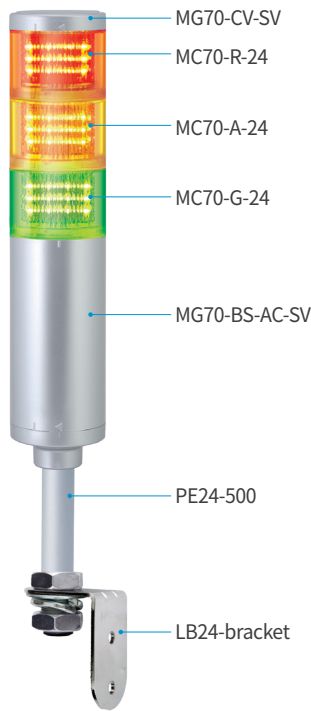
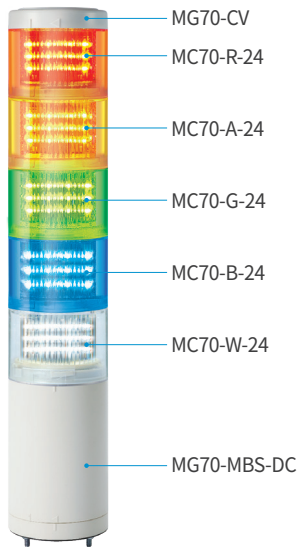

Ordering Specifications

[Upper module]	[LED module]	[Base module]	[Pole]	[Bracket]
MG70-CV-SV	MC70-R/A/G/B-24	MG70-BS-AC-SV	PE24-500	LB24
Cover module Buzzer module Cover integrated LED module	● R-Red ● A-Amber ● G-Green ● B-Blue ○ W-White	Pole mount type Self stand type M12 connector type	(Blank)-Self stand type, M12 connector type Pole type	(Blank)-Self stand type, M12 connector type Pole type, Self stand type(Optional)

Example of MTR70 module configuration

- You can assemble the product through module combination by referring to the diagram below.
- When a buzzer module (standard buzzer module/high volume buzzer module/waterproof buzzer module) is combined, only 4 LED modules can be assembled (W color module cannot be assembled).

MTR70ML-24-3-RAG-BK		MTR70L-HBZ-24-3-RAG-QZ24-BK		MTRA70L-24-4-RAGB-M12-BK	
Layout	Modules	Layout	Modules	Layout	Modules

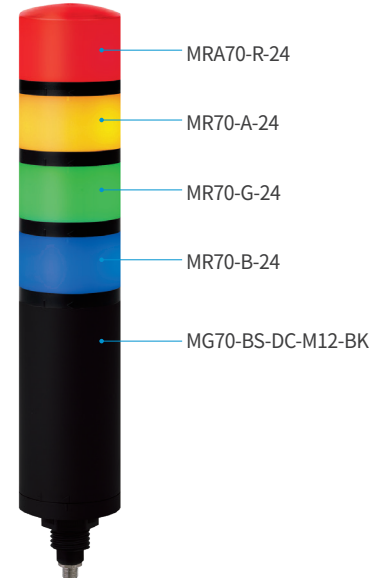
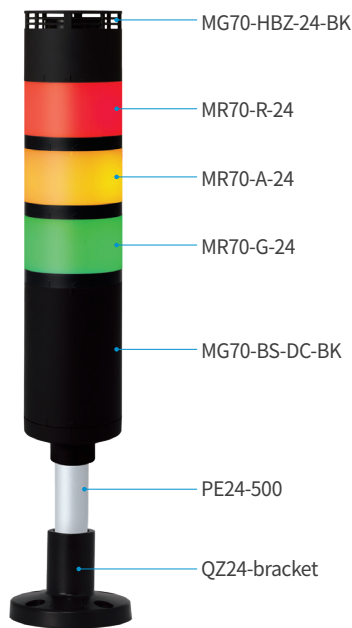
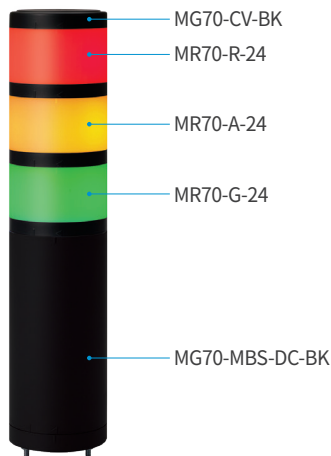

Cover module-Black + LED module + MBS module-Black (Self stand type module)	Buzzer module-Black + LED module + BS module-Black(Pole type module) + POLE + Mount bracket	Cover integrated LED module + LED module + BS module-Black (M12 connector type module)
--	---	---

Ordering Specifications

[Upper module]	[LED module]	[Base module]	[Pole]	[Bracket]
MG70-HBZ-24-BK	MR70-R/A/G/B/W-24	MG70-BS-DC-BK	PE24-500	QZ24
Cover module Buzzer module Cover integrated LED module	● R-Red ● A-Amber ● G-Green ● B-Blue ○ W-White	Pole mount type Self stand type M12 connector type	(Blank)-Self stand type, M12 connector type Pole type	(Blank)-Self stand type, M12 connector type Pole type, Self stand type(Optional)

Modular LED signal tower light with built-in terminal

MTG / MTC / MTR Series

Technical Diagram

Units : mm

- MTG50ML-DC ·MTG50ML-AC ·MTG50ML-BZ-AC
- MTG50MLF-DC ·MTG50MLF-AC ·MTG50MLF-BZ-AC

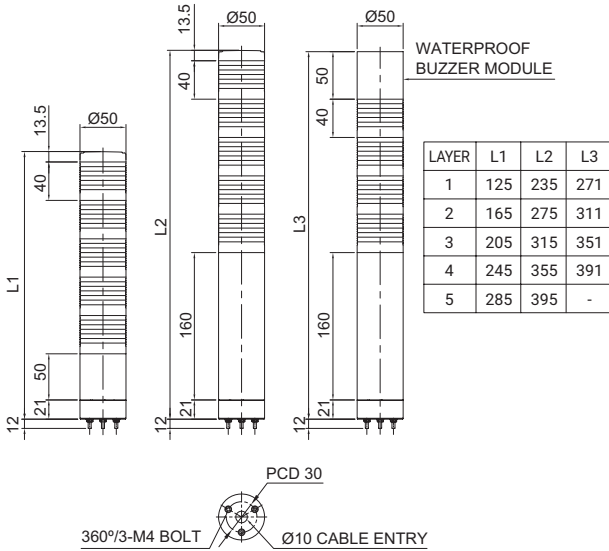

- MTG60ML-DC ·MTG60ML-AC ·MTG60ML-BZ-AC
- MTG60MLF-DC ·MTG60MLF-AC ·MTG60MLF-BZ-AC

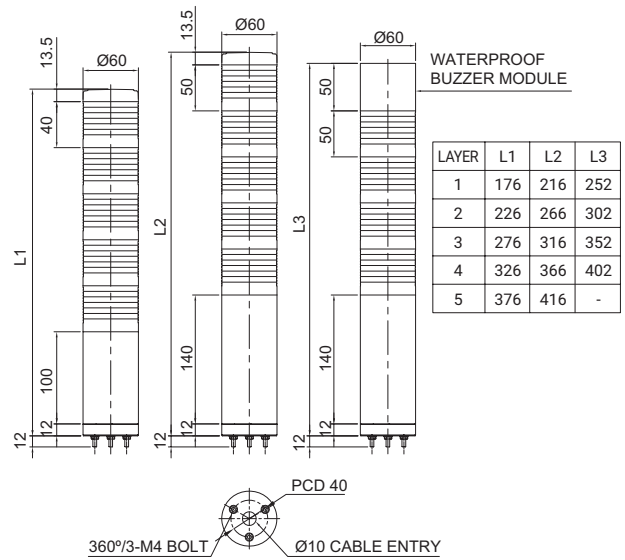

- MTG50L-DC ·MTG50L-AC ·MTG50L-BZ-AC
- MTG50LF-DC ·MTG50LF-AC ·MTG50LF-BZ-AC

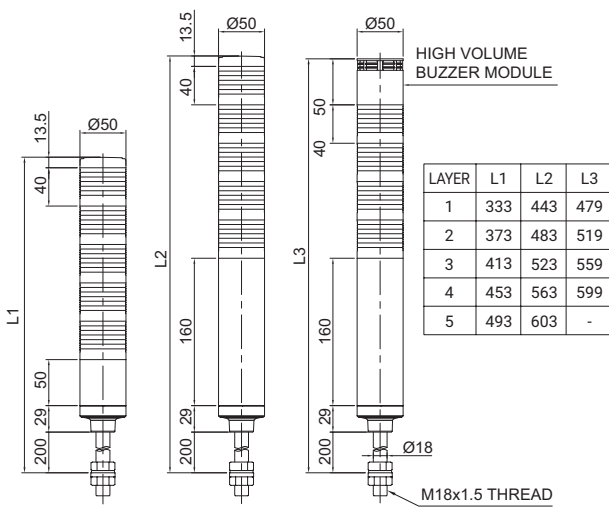

- MTG60L-DC ·MTG60L-AC ·MTG60L-BZ-AC
- MTG60LF-DC ·MTG60LF-AC ·MTG60LF-BZ-AC

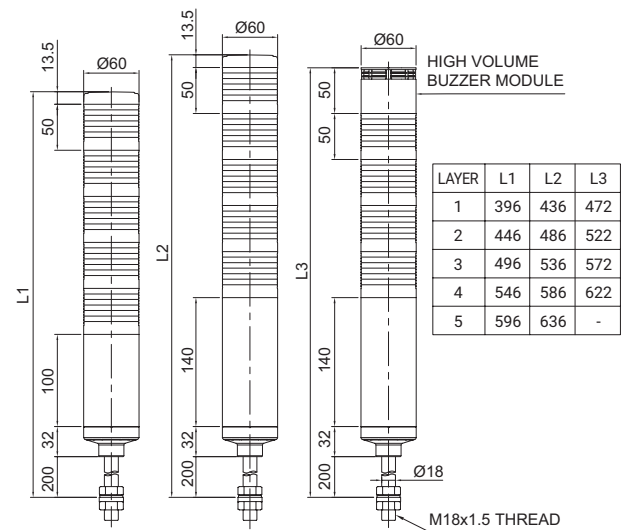

- MTG50L-M12-DC ·MTG50L-M12-AC ·MTG50L-BZ-M12-AC
- MTG50LF-M12-DC ·MTG50LF-M12-AC ·MTG50LF-BZ-M12-AC

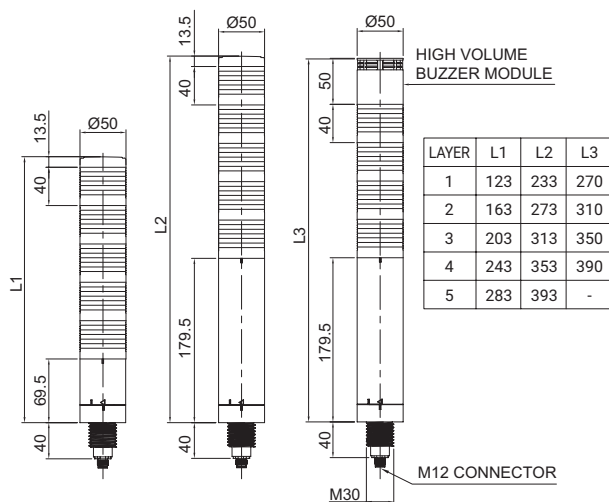

- MTG60L-M12-DC ·MTG60L-M12-AC ·MTG60L-BZ-M12-AC
- MTG60LF-M12-DC ·MTG60LF-M12-AC ·MTG60LF-BZ-M12-AC

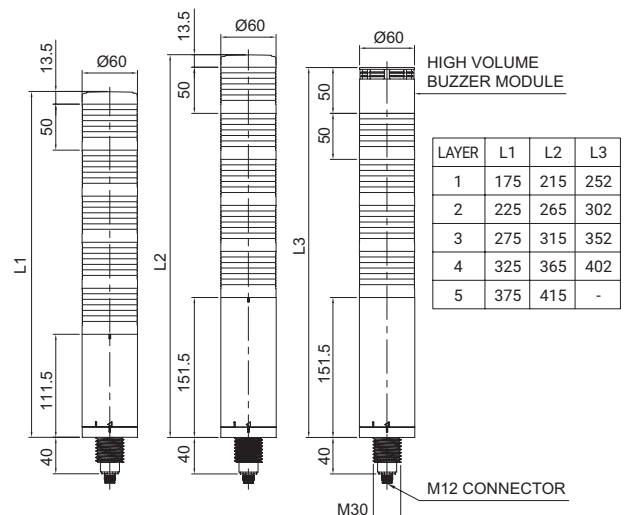

- MTG70ML-DC ·MTG70ML-AC ·MTG70ML-BZ-AC
- MTG70MLF-DC ·MTG70MLF-AC ·MTG70MLF-BZ-AC

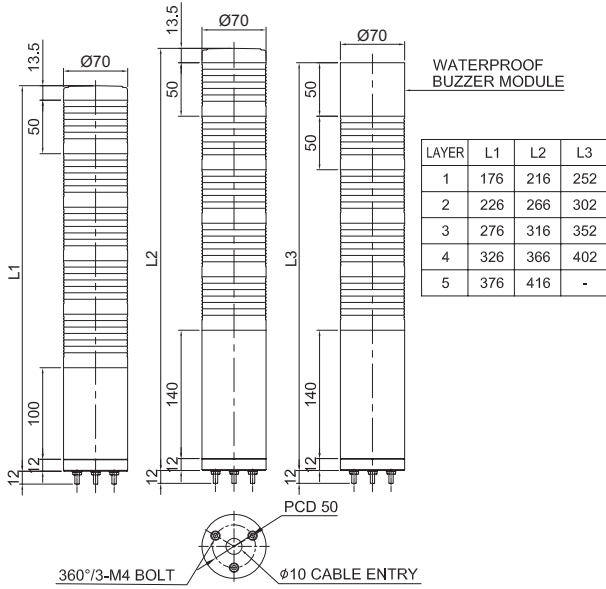

- MTG70L-DC ·MTG70L-AC ·MTG70L-BZ-AC
- MTG70LF-DC ·MTG70LF-AC ·MTG70LF-BZ-AC

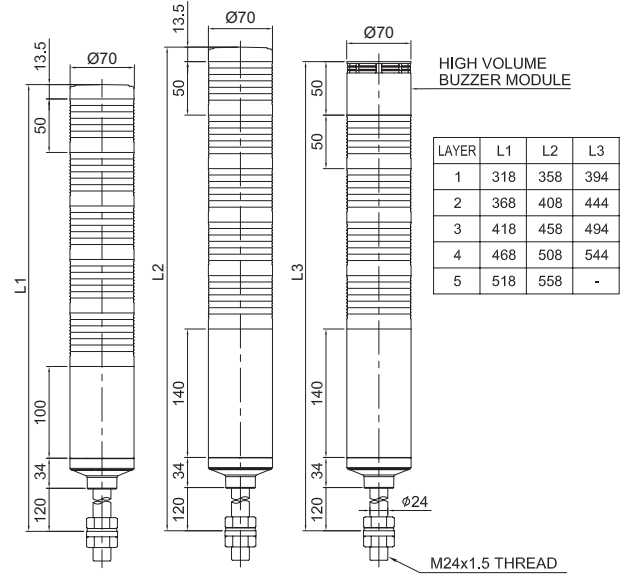

- MTG70L-M12-DC ·MTG70L-M12-AC ·MTG70L-BZ-M12-AC
- MTG70LF-M12-DC ·MTG70LF-M12-AC ·MTG70LF-BZ-M12-AC

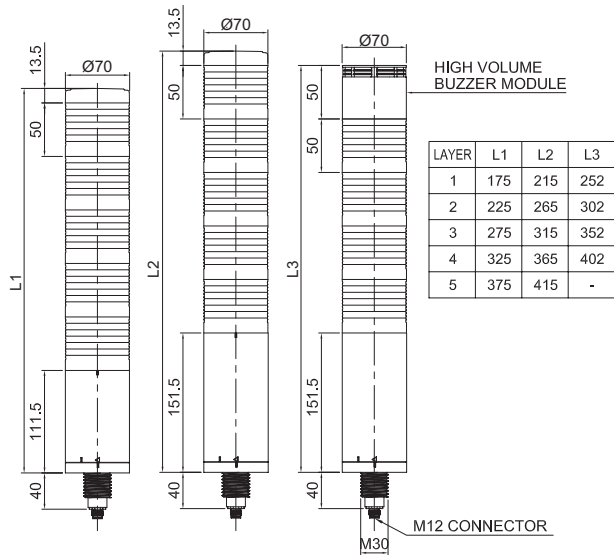

* For external dimensions of MTC / MTR products, refer to the MTG model.

MTG Series

Wiring Instructions(Wiring using external contact)

· In case of wiring with external contacts, refer to the wiring diagrams below according to your product's type and voltage setting.

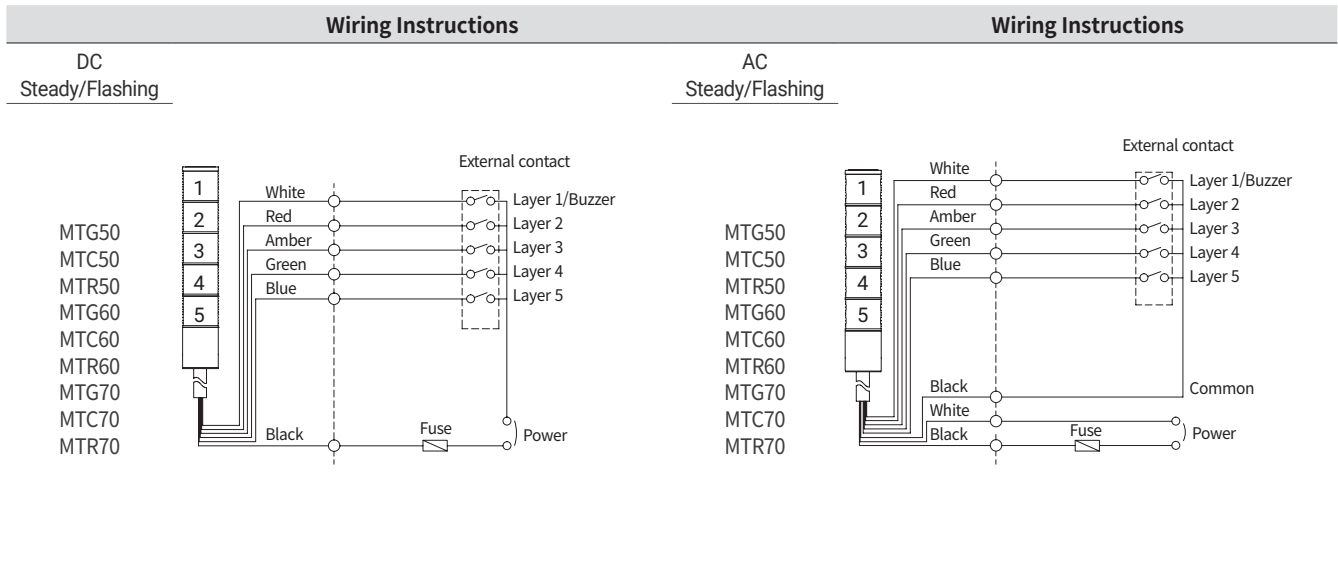

Wiring Instructions(Wiring using transistor)

· When using a transistor, please choose between the NPN or PNP type transistor which best matches the voltage and product type, then connect them correctly according to the wiring diagrams below.

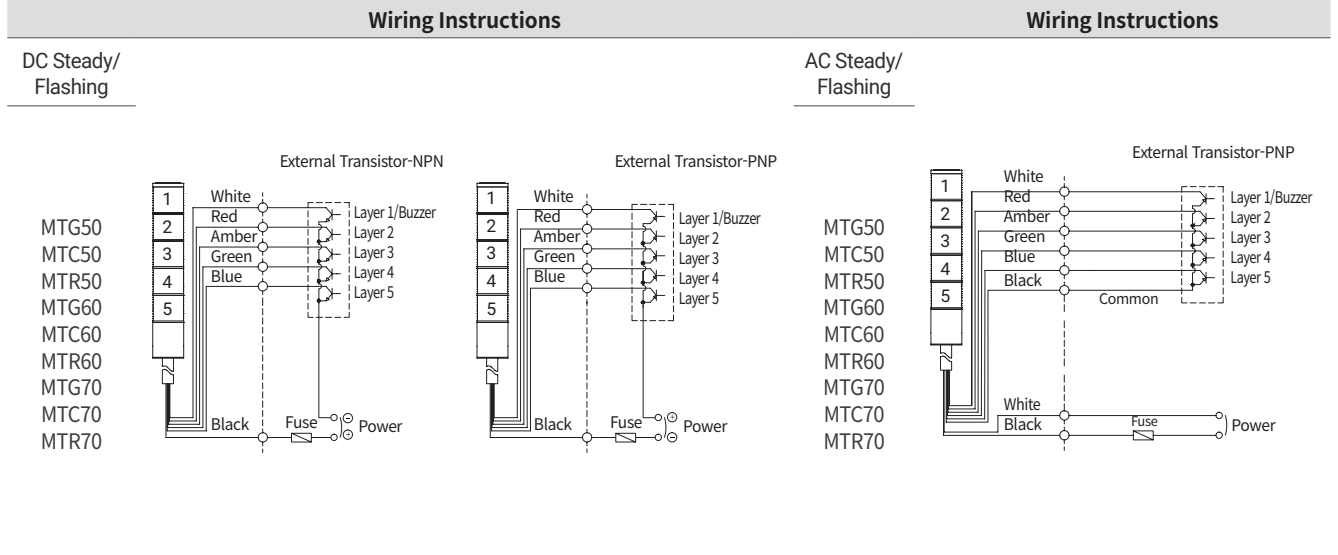

Recommended signal line information

- External power line - UL1015 AWG18(0.75sq) x 2C 400mm
- External signal line - UL1007 AWG22(0.3sq) 400mm
- LED light source tower lamp can be connected using external contacts and transistors.
- The wiring method for MTG / MTC / MTR products is the same.