



# RUT204

## CAN BUS LTE ROUTER



Energy &  
utilities



Industrial &  
automation



Smart city



Transportation

### NATIVE CAN BUS

Enable direct access to machine data with CANOpen and J1939 protocol support

### DATA LOGGING

Collect and send data to local or cloud servers for monitoring and analysis

### VERSATILE INTERFACES

Simplify industrial installations with GNSS, RS232, PoE-in, and Ethernet

### REMOTE FLEET MANAGEMENT

Manage connected devices remotely via RMS with zero-touch deployment

## Mobile

|                             |  |
|-----------------------------|--|
| Mobile module               | 4G LTE Cat 4 up to 150 DL/50 UL Mbps; 3G up to 21 DL/5.76 UL Mbps; 2G up to 236.8 DL/236.8 UL kbps   |
| 3GPP Release                | Release 9  |
| SIM switch                  | 2 SIM cards, auto-switch cases: weak signal, data limit, SMS limit, roaming, no network, network denied, data connection fail, SIM idle protection   |
| SIM switch                  | 2 SIM cards, auto-switch cases: weak signal, data limit, SMS limit, roaming, no network, network denied, data connection fail, SIM idle protection   |
| Status                      | IMSI, ICCID, operator, operator state, data connection state, network type, bandwidth, connected band, signal strength (RSSI), SINR, RSRP, RSRQ, EC/IO, RSCP, data sent/received, LAC, TAC, cell ID, ARFCN, UARFCN, EARFCN, MCC, and MNC |
| SMS                         | SMS status, SMS configuration, EMAIL to SMS, SMS to EMAIL, SMS to HTTP, SMS to SMS, scheduled SMS, SMS autoreply, SMPP   |
| USSD                        | Supports sending and reading Unstructured Supplementary Service Data messages  |
| Block/Allow list            | Operator block/allow list (by country or separate operators)   |
| Band management             | Band lock, Used band status display  |
| SIM idle protection service | Provides the possibility to configure the router to periodically switch to the unused SIM card and establish a data connection in order to prevent the SIM card from being blocked   |
| SIM PIN code management     | SIM PIN code management enables setting, changing, or disabling the SIM card's PIN   |
| APN                         | Auto APN   |
| Bridge                      | Direct connection (bridge) between mobile ISP and device on LAN  |
| Passthrough                 | Router assigns its mobile WAN IP address to another device on LAN  |

## Wireless

|                                |  |
|--------------------------------|--|
| Wireless mode                  | 802.11b/g/n (Wi-Fi 4), Access Point (AP), Station (STA)  |
| Wi-Fi security                 | WPA2-Enterprise: PEAP, WPA2-PSK, WPA-EAP, WPA-PSK, WPA3-SAE, WPA3-EAP, OWE; AES-CCMP, TKIP, Auto-cipher modes, client separation, EAP-TLS with PKCS#12 certificates, disable auto-reconnect, 802.11w Protected Management Frames (PMF) |
| SSID/ESSID                     | SSID stealth mode and access control based on MAC address  |
| Wi-Fi users                    | Up to 50 simultaneous connections  |
| Wireless Connectivity Features | Fast roaming (802.11r), Relayd, BSS transition management (802.11v), radio resource measurement (802.11k)  |
| Wireless MAC filter            | Allowlist, blocklist   |
| Wireless QR code generator     | Once scanned, a user will automatically enter your network without needing to input login information  |
| TravelMate                     | Forward Wi-Fi hotspot landing page to a subsequent connected device  |

## Ethernet

|     |  |
|-----|--|
| WAN | 1 x WAN port 10/100 Mbps, compliance with IEEE 802.3, IEEE 802.3u, 802.3az standards, supports auto MDI/MDIX crossover   |
| LAN | 1 x LAN ports, 10/100 Mbps, compliance with IEEE 802.3, IEEE 802.3u, 802.3az standards, supports auto MDI/MDIX crossover |

## Network

|                                    |  |
|------------------------------------|--|
| Routing                            | Static routing, Dynamic routing (BGP, OSPF v2, RIP v1/v2, EIGRP, NHRP), Policy based routing   |
| Network protocols                  | TCP, UDP, IPv4, IPv6, ICMP, NTP, DNS, HTTP, HTTPS, SFTP, FTP, SMTP, SSL v3, TLS, ARP, VRRP, PPP, PPPoE, UPNP, SSH, DHCP, Telnet, SMPP, SNMP, MQTT, Wake on Lan (WOL), VXLAN  |
| VoIP passthrough support           | H.323 and SIP-alg protocol NAT helpers, allowing proper routing of VoIP packets  |
| Connection monitoring              | Ping Reboot, Wget Reboot, Periodic Reboot, LCP and ICMP for link inspection  |
| Firewall                           | Port forward, traffic rules, custom rules, TTL target customisation  |
| Firewall status page               | View all your Firewall statistics, rules, and rule counters  |
| Port management                    | View device ports, enable and disable each of them, turn auto-configuration on or off, change their transmission speed, and so on  |
| Network topology                   | Visual representation of your network, showing which devices are connected to which other devices  |
| DHCP                               | Static and dynamic IP allocation, DHCP relay, DHCP server configuration, status, static leases: MAC with wildcards   |
| QoS / Smart Queue Management (SQM) | Traffic priority queuing by source/destination, service, protocol or port, WMM, 802.11e  |
| DDNS                               | Supported >77 service providers, others can be configured manually   |
| DNS over HTTPS                     | DNS over HTTPS proxy enables secure DNS resolution by routing DNS queries over HTTPS   |
| Network backup                     | Wi-Fi WAN, Mobile, VRRP, Wired options, each of which can be used as an automatic Failover   |
| Load balancing                     | Balance Internet traffic over multiple WAN connections   |
| Hotspot                            | Captive portal (hotspot), internal/external Radius server, Radius MAC authentication, SMS authorisation, SSO authentication, internal/external landing page, walled garden, user scripts, URL parameters, user groups, individual user or group limitations, user management, 9 default customisable themes and optionality to upload and download customised hotspot themes |
| Hotspot 2.0                        | Hotspot 2.0 is a Wi-Fi standard that enables seamless, secure, and automatic connection to trusted wireless networks   |
| SSHFS                              | Possibility to mount remote file system via SSH protocol   |
| Traffic Management                 | Real-time monitoring, wireless signal charts, traffic usage history  |

## Security

|                      |  |
|----------------------|--|
| Authentication       | Pre-shared key, digital certificates, X.509 certificates, TACACS+, Internal & External RADIUS users authentication, IP & login attempts block, time-based login blocking, built-in random password generator |
| Firewall             | Preconfigured firewall rules can be enabled via WebUI, unlimited firewall configuration via CLI, DMZ, NAT, NAT-T, NAT64  |
| Attack prevention    | DDOS prevention (SYN flood protection, SSH attack prevention, HTTP/HTTPS attack prevention), port scan prevention (SYN-FIN, SYN-RST, X-mas, NULL flags, FIN scan attacks)                                    |
| VLAN                 | Port and tag-based VLAN separation   |
| Mobile quota control | Mobile data limit, customizable period, start time, warning limit, phone number  |
| WEB filter           | Block list for blocking out unwanted websites, allow list for specifying allowed sites only  |
| Access control       | Flexible access control of SSH, Web interface, CLI and Telnet  |
| Certificate Manager  | Certificate creation tool allows to create CA, server, client, let's encrypt, SCEP certificates  |
| 802.1x               | Port-based network access control server   |

## VPN

|                    |   |
|--------------------|---|
| OpenVPN            | Multiple clients and a server can run simultaneously, 27 encryption methods   |
| OpenVPN Encryption | DES-CBC 64, RC2-CBC 128, DES-EDE-CBC 128, DES-EDE3-CBC 192, DESX-CBC 192, BF-CBC 128, RC2-40-CBC 40, CAST5-CBC 128, RC2-64-CBC 64, AES-128-CBC 128, AES-128-CFB 128, AES-128-CFB1 128, AES-128-CFB8 128, AES-128-OFB 128, AES-128-GCM 128, AES-192-CFB 192, AES-192-CFB1 192, AES-192-CFB8 192, AES-192-OFB 192, AES-192-CBC 192, AES-192-GCM 192, AES-256-GCM 256, AES-256-CFB 256, AES-256-CFB1 256, AES-256-CFB8 256, AES-256-OFB 256, AES-256-CBC 256 |
| IPsec              | XFRM, IKEv1, IKEv2, with 14 encryption methods for IPsec (3DES, DES, AES128, AES192, AES256, AES128GCM8, AES192GCM8, AES256GCM8, AES128GCM12, AES192GCM12, AES256GCM12, AES128GCM16, AES192GCM16, AES256GCM16)  |
| GRE                | GRE tunnel, GRE tunnel over IPsec support   |
| PPTP, L2TP         | Client/Server instances can run simultaneously, L2TPv3, L2TP over IPsec support   |
| Stunnel            | Proxy designed to add TLS encryption functionality to existing clients and servers without any changes in the program's code  |
| DMVPN              | Method of building scalable IPsec VPNs, Phase 2 and Phase 3 and Dual Hub support  |
| SSTP               | SSTP client instance support  |
| ZeroTier           | ZeroTier VPN client support   |
| WireGuard          | WireGuard VPN client and server support   |
| Tinc               | Tinc offers encryption, authentication and compression in it's tunnels. Client and server support.  |
| EoIP               | Ethernet over IP (EoIP) Tunneling is a MikroTik RouterOS protocol based on GRE RFC 1701 that creates an Ethernet tunnel between two routers on top of an IP connection  |
| OpenConnect        | Cross-platform multi-protocol SSL VPN client which supports a number of VPN protocols   |

### BacNET

|                            |   |
|----------------------------|---|
| Supported modes            | Router  |
| Supported connection types | RTU(RS232)  |
| Configuration options      | Support for multiple BACnet/IP interfaces, Network number assignment, Preconfigured BDT entries for BBMD (BACnet Broadcast Management Device) |

### OPC UA

|                            |                |
|----------------------------|----------------|
| Supported modes            | Client, Server |
| Supported connection types | TCP            |

### MODBUS

|                            |  |
|----------------------------|--|
| Supported modes            | Server, Client   |
| Supported connection types | RTU(RS232)   |
| Custom registers           | MODBUS TCP custom register block requests, which read/write to a file inside the router, and can be used to extend MODBUS TCP Client functionality |
| Supported data formats     | 8-bit: INT, UINT; 16-bit: INT, UINT (MSB or LSB first); 32-bit: float, INT, UINT (ABCD (big-endian), DCBA (little-endian), CDAB, BADC), HEX, ASCII |

### Data to Server

|                |   |
|----------------|---|
| Protocol       | HTTP(S), MQTT, Azure MQTT   |
| Data to server | Extract parameters from multiple sources and different protocols, and send them all to a single server; Custom LUA scripting, allowing scripts to utilize the router's Data to server feature |

### MQTT Gateway

|                     |   |
|---------------------|---|
| Modbus MQTT Gateway | Allows sending commands and receiving data from MODBUS Server through MQTT broker |
|---------------------|---|

### DNP3

|                            |                             |
|----------------------------|-----------------------------|
| Supported modes            | TCP Master, DNP3 Outstation |
| Supported connection types | RTU(RS232)                  |

### DLMS/COSEM

|                            |  |
|----------------------------|--|
| DLMS Support               | DLMS - standard protocol for utility meter data exchange |
| Supported modes            | Client   |
| Supported connection types | TCP, RTU(RS232)  |

## CAN

|                            |  |
|----------------------------|--|
| CAN Gateway                | Allows forwarding CAN frames over IP networks.           |
| CANopen Client (Planned)   | Allows data collection and monitoring from other devices |
| SAE J1939 Client (Planned) | Allows data collection and monitoring from other devices |

## API

|   |   |
|---|---|
| Teltonika Networks Web API (beta) support | Expand your device's possibilities by using a set of configurable API endpoints to retrieve or change data. For more information, please refer to this documentation: <a href="https://developers.teltonika-networks.com">https://developers.teltonika-networks.com</a> |
|---|---|

## Monitoring & Management

|          |   |
|----------|---|
| WEB UI   | HTTP/HTTPS, status, configuration, FW update, CLI, troubleshoot, multiple event log servers, firmware update availability notifications, event log, system log, kernel log, Internet status |
| FOTA     | Firmware update from server, automatic notification   |
| SSH      | SSH (v1, v2)  |
| SMS      | SMS status, SMS configuration   |
| Call     | Reboot, Status, Mobile data on/off, Output on/off, answer/hang-up with a timer, Wi-Fi on/off  |
| TR-069   | OpenACS, EasyCwmp, ACSLite, tGem, LibreACS, GenieACS, FreeACS, LibCWMP, Friendly tech, AVSystem   |
| MQTT     | MQTT Broker, MQTT publisher   |
| SNMP     | SNMP (v1, v2, v3), SNMP Trap, Brute force protection  |
| JSON-RPC | Management API over HTTP/HTTPS  |
| RMS      | Teltonika Remote Management System (RMS)  |

## IoT Platforms

|                              |   |
|------------------------------|---|
| ThingWorx                    | Allows monitoring of: WAN Type, WAN IP, Mobile Operator Name, Mobile Signal Strength, Mobile Network Type   |
| Cumulocity - Cloud of Things | Allows monitoring of: Device Model, Revision and Serial Number, WAN Type and IP, Mobile Cell ID, ICCID, IMEI, Connection Type, Operator, Signal Strength. Has reboot and firmware upgrade actions   |
| Azure IoT Hub                | Can be configured with Data to Server to send all the available parameters to the cloud. Has Direct method support which allows to execute RutOS API calls on the IoT Hub. Also has Plug and Play integration with Device Provisioning Service that allows zero-touch device provisioning to IoT Hubs |
| AWS IoT Core                 | Utility to interact with the AWS cloud platform. Jobs Support: Call the device's API using AWS Jobs functionality   |

### System Characteristics

|               |                                   |
|---------------|-----------------------------------|
| CPU           | Mediatek, 575/580 MHz, MIPS 24KEc |
| RAM           | 128 MB, DDR2                      |
| FLASH storage | 32 MB, NOR Flash                  |

### Firmware/Configuration

|                        |   |
|------------------------|---|
| WEB UI                 | Update FW from file, check FW on server, configuration profiles, configuration backup   |
| FOTA                   | Update FW   |
| RMS                    | Update FW/configuration for multiple devices at once  |
| Keep settings          | Update FW without losing current configuration  |
| Factory settings reset | A full factory reset restores all system settings, including the IP address, PIN, and user data to the default manufacturer's configuration |

### FIRMWARE CUSTOMISATION

|                     |   |
|---------------------|---|
| Operating system    | RutOS (OpenWrt based Linux OS)  |
| Supported languages | Busybox shell, Lua, C, C++  |
| Development tools   | SDK package with build environment provided   |
| GPL customization   | You can create your own custom, branded firmware and web page application by changing colours, logos, and other elements in our firmware to fit your or your clients' needs |
| Package Manager     | The Package Manager is a service used to install additional software on the device  |

### Location Tracking

|                 |  |
|-----------------|--|
| GNSS            | GPS, GLONASS, BeiDou, Galileo and QZSS                             |
| Coordinates     | GNSS coordinates via WebUI, SMS, TAVL, RMS                         |
| NMEA            | NMEA 0183  |
| NTRIP           | NTRIP protocol (Networked Transport of RTCM via Internet Protocol) |
| Server software | Supported server software TAVL, RMS                                |
| Geofencing      | Configurable multiple geofence zones                               |

### Serial

|                  |  |
|------------------|--|
| RS232            | RS232 only TX and RX signals                                 |
| CAN              | Integrated CAN interface                                     |
| Serial functions | Console, Serial over IP, Modem, MODBUS gateway, NTRIP Client |

### Input/Output

|        |                 |
|--------|-----------------|
| Events | Email, RMS, SMS |
|--------|-----------------|

### SD CARD

|                 |                               |
|-----------------|-------------------------------|
| Physical size   | Micro SD (internal)           |
| Applications    | Samba share                   |
| Capacity        | Up to 2 TB                    |
| Storage formats | FAT32, NTFS, ext2, ext3, ext4 |

### POE IN

|               |  |
|---------------|--|
| PoE ports     | 1 x PoE In   |
| PoE standards | Active PoE input 802.3af Class 0 (12.94 W) on LAN port |

### Power

|                     |   |
|---------------------|---|
| Connector           | 2-pin industrial DC power socket  |
| Input voltage range | 9 - 57 VDC, reverse polarity protection 100 V max, surge protection min 64.4 V/max 71.2 V breakdown voltage, 93.6 V max reverse voltage @ 4.3 A max reverse surge current |
| PoE (passive)       | Passive PoE over spare pairs 4,5 (+) / 7,8 (-). Possibility to power up through LAN port, passive PoE voltage: 16 - 57 VDC  |
| Power consumption   | Idle: < 2 W, Max: < 3.5 W   |

### Physical Interfaces

|             |   |
|-------------|---|
| Ethernet    | 2 x RJ45 ports, 10/100 Mbps   |
| Status LEDs | 1 x Connection type status RGB LED, 1 x Connection strength RGB LED, 2 x ETH status LEDs, 1 x Power LED |
| SIM         | 2 x internal SIM slots (Mini SIM – 2FF), 1.8 V/3 V, double stacked SIM tray                             |
| Power       | 1 x 2-pin power connector   |
| Antennas    | 2 x SMA for Mobile, 1 x RP-SMA for Wi-Fi, 1 x SMA for GNSS  |
| RS232, CAN  | 1 x 6-pin terminal block  |
| Reset       | Reboot/User default reset/Factory reset button  |

### Physical Specification

|                        |   |
|------------------------|---|
| Casing material        | Aluminum housing and panels                                     |
| Dimensions (W x H x D) | 83 x 25 x 83 mm   |
| Weight                 | 140 g   |
| Mounting options       | DIN rail, wall mount, flat surface (all require additional kit) |

### Operating Environment

|                           |                           |
|---------------------------|---------------------------|
| Operating temperature     | -40 °C to 75 °C           |
| Operating humidity        | 10% to 90% non-condensing |
| Ingress Protection Rating | IP30                      |

**Regulatory & Type Approvals**

---

|            |                              |
|------------|------------------------------|
| Regulatory | CE, UKCA, CB, RCM, EAC, UCRF |
|------------|------------------------------|

## Hardware

### FRONT VIEW

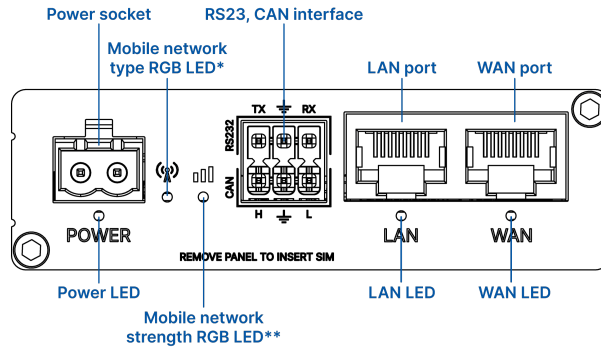

|                                  |  |
|----------------------------------|--|
| Mobile network type RGB LED*     | RED - 2G connection<br>YELLOW - 3G Connection<br>GREEN - 4G connection                             |
| Mobile signal strength RGB LED** | None $\leq$ -111 dBm<br>RED -110 dBm to -82 dBm<br>GREEN -81 dBm to -52 dBm<br>BLUE $\geq$ -51 dBm |

### BACK VIEW

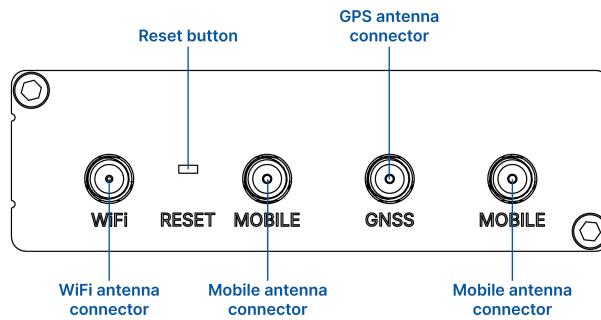

### 6-PIN TERMINAL BLOCK

1. RS232 driver signal (TX)
2. Device ground (GND)
3. RS232 receiver signal (RX)
4. Low-level (H)
5. Device ground (GND)
6. High-level (L)

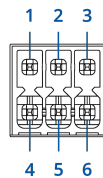

### POWER SOCKET PINOUT

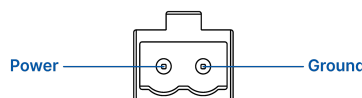

## Ordering

Standard package\*



RUT204



QUICK START GUIDE

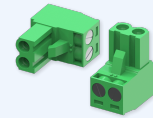

2-PIN TERMINAL BLOCK

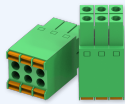

2X3PIN CONNECTOR



HEX KEY

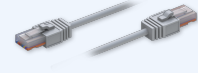

ETHERNET CABLE 1.5 M



SIM ADAPTER KIT

\*Standard package contents may differ based on standard order codes.

For more information on all available packaging options – please [contact us](#) directly.

## Classification codes

**HS Code:** 851762

**HTS:** 8517.62.00

For more information on all available packaging options – please [contact us](#) directly.

## Available versions

| Hardware version   | Supported frequencies   | Standard order code / Package Contains  |
|--|---|---|
| RUT204 *A****<br>Europe <sup>1</sup> , Australia, Asia-Pacific | <b>4G (LTE-FDD):</b> B1, B3, B5, B7, B8, B20, B28<br><b>4G (LTE-TDD):</b> B38, B40, B41<br><b>3G:</b> B1, B5, B8<br><b>2G:</b> B3, B8 | RUT2040AAAA0 / Standard package without PSU<br>RUT2040AAAD0 / Mass packing code |

The price and lead-times for region (operator) specific versions may vary. For more information please [contact us](#).

1 - Regional availability - excluding Russia, Belarus & Iran

## RUT204 spatial measurements

### Available versions

|                            |                   |
|----------------------------|-------------------|
| Device housing (W x H x D) | 83 x 25 x 83 mm   |
| Box:                       | 100 x 32 x 108 mm |

**TOP VIEW**

The figure below depicts the measurements of device and its components as seen from the top:

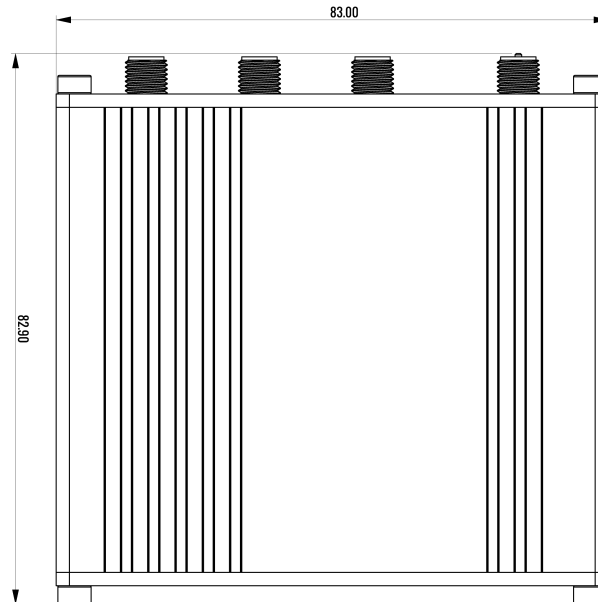

**RIGHT VIEW**

The figure below depicts the measurements of device and its components as seen from the right:

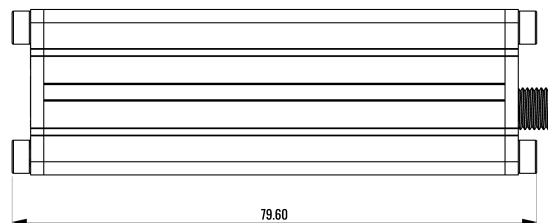

**FRONT VIEW**

The figure below depicts the measurements of device and its components as seen from the front panel side:

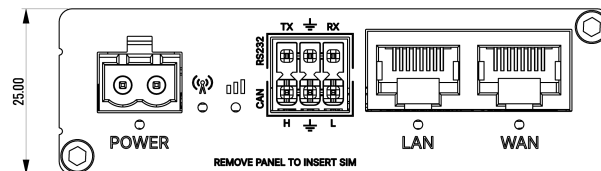

## REAR VIEW

The figure below depicts the measurements of device and its components as seen from the back panel side:

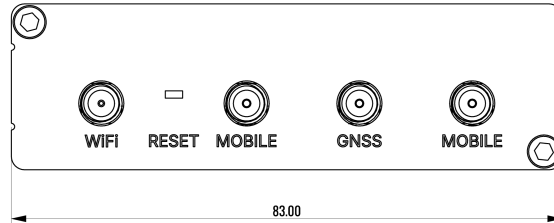

## MOUNTING SPACE REQUIREMENTS

The figure below depicts an approximation of the device's dimensions when cables and antennas are attached:

