



# Safety Interlock Switch with Guard Locking

## KLP Operating Instructions



Plastic Body

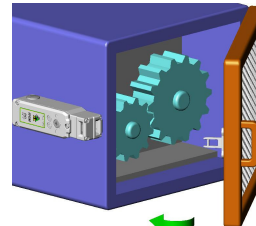

Hinged Guard

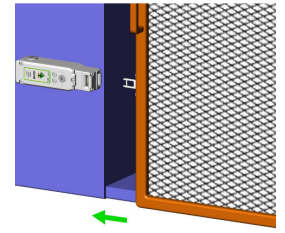

Sliding Guard

### IMPORTANT NOTE:

Read and understand these instructions before installing, operating, or maintaining this equipment.

The product is designed to be a component of a customised safety orientated control system. It is the responsibility of the user to ensure the correct overall functionality of its systems and machines. IDEM, its subsidiaries and affiliates, are not in a position to guarantee all of the characteristics of a given system or product not designed by IDEM.

### Application and Operation:

Safety Interlock Switches with Guard Locking are designed to fit to the leading edge of sliding or hinged guard doors to provide positively operated switching contacts and provide a tamper resistant key mechanism. They are designed to provide robust position interlock detection and holding closed of moving guards. The switch is rigidly mounted to the frame of the guard or machine. The actuator is fitted to the moving part (frame) of the guard and is aligned to the switch entry aperture. The actuator profile is designed to match a cam mechanism within the switch head and provides a positively operated not easily defeatable interlock switch. When the guard is closed and the actuator is inserted into the switch the safety contacts close, the actuator is locked and the machine start circuit can be enabled. When the solenoid is energised the safety contacts are positively opened, the machine stop circuit is broken and the guard door can be opened.

### Installation:

- Installation of all interlock switches must be in accordance with a risk assessment for the individual application. Installation must only be carried out by competent personnel and in accordance with these instructions.
- M5 mounting bolts must be used to fix the switch and actuator, the tightening torque to ensure reliable fixing is 4.0 Nm. **To prevent loosening of the switch after installation, always fix the M5 mounting bolts with a thread-locking compound or secure using self locking nuts.** Tightening torque for the lid screws, conduit entry plugs and cable glands must be 1.5 Nm to ensure IP seal. Only use the correct size gland for the conduit entry and cable outside diameter. Tightening torque for the connection terminal screws is 0.7 Nm, max conductor size is 1.0 sq.mm. The switch head position can be selected by removing the actuator, loosening the 4 head bolts and then rotating the head to the position required. Re-tighten the head bolts and then check actuator insertion and withdrawal. Tightening torque for the head bolts is 1.5Nm.

- Always fit a mechanical stop to the guard to prevent damage to the front of the switch. Set the actuator gap to 3mm when the guard is closed and against the stop. (See Fig. A.) Use alignment guides to ensure that the actuator enters the switch without interfering with the sides of the switch aperture. If fitted, ensure access to at least one of the auxiliary release points. The switch can be positioned / shielded to prevent unintended actuation of the auxiliary release. The auxiliary release function is achieved by use of a tool and is to be used in exceptional circumstances. The auxiliary release can be protected by use of a tamper coating to protect against unintended operation. If operated this tamper protection must be restored. Always fit the aperture plug to the unused entry aperture to prevent debris entering the switch mechanism.

- After installation check operation of all control circuits and the locking function. For applications with a run down time after removing power, ensure that the correct timing allowance has elapsed before energising the solenoid. LED 1 RED will illuminate when power is applied to A1 and A2 (solenoid feed). LED 2 GREEN (if used) will be illuminated when the actuator is locked.

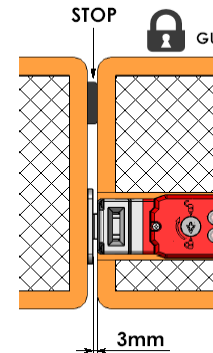
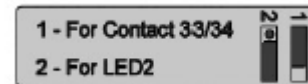

Fig. A

### 5. IMPORTANT!

At installation choose the status of Terminals 33 and 34 by setting the slide switch inside the switch housing.



If LED2 is used always check for correct .dc polarity.  
Terminal 33: 0V.dc Terminal 34: +24V.dc

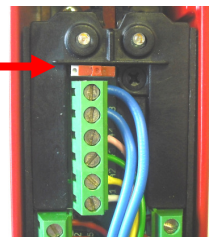

Fig. B



Top or Side  
Auxiliary release points (if fitted)

8 actuator entry positions  
rotatable head

### IMPORTANT

The Risk Assessment for the particular application should include the risk of spare actuators. Spare actuators should not be readily available and must be securely controlled.

Application consideration must be given to the fixing of the actuator which has to be in a way that prevents disassembly by easy means. It should not be possible to operate the manual escape release from outside of the safeguarded area. Measures should be taken to reduce the risk of improper activation.

Ensure that the switch holding force (Fzh) is sufficient to withstand the static forces applied during normal use and dynamic effects caused by bouncing of the guard shall not create an impact reaction force which exceeds the holding force. If the expected impact reaction forces are higher than the specified holding force for the switch, then design measures must be applied to avoid the force.

The safety functions and mechanics must be tested regularly. For applications where infrequent guard access is foreseeable, the system must have a manual function test to detect a possible accumulation of faults.

At least once per month for PL e Cat3/4 or once per year for PL d Cat3 (ISO13849-1).

Where possible it is recommended that the control system of the machine demands and monitors these tests, and stops or prevents the machine from starting if the test is not done. (See ISO14119).

### Maintenance:

Every Month: Check the switch actuator and body for signs of mechanical damage and wear. Replace any switch showing damage.

Every 6 Months: Check for mechanical damage to switch body or actuator. Isolate power and remove cover. Check screw terminal tightness and check for signs of moisture ingress. Never attempt to repair any switch. Replace any switch displaying damage. **These requirements form part of the product warranty.**

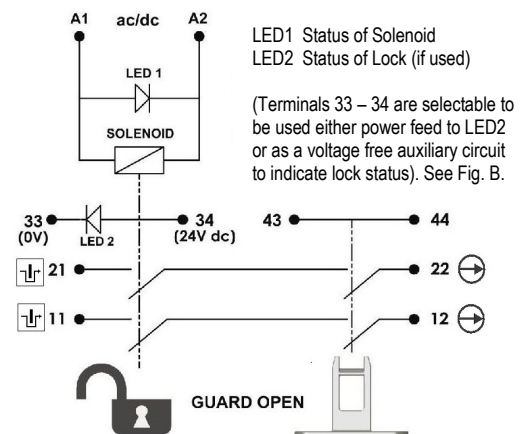

# Safety Interlock Switch with Guard Locking

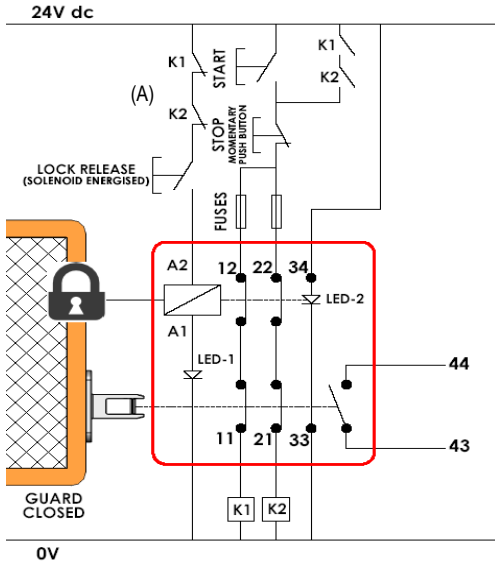

## Application Example: Door Interlock with Guard locking - Dual Channel (non-monitored).

The guard is locked closed until the solenoid is energized. The solenoid can only be energized when the auxiliary contacts (A) of contactors K1 and K2 are closed. When the lock release button is pushed the locking mechanism is released and the switch contacts 11-12 and 21-22 are opened. These contacts are in series with contactor coils of K1 and K2 and will prevent re-start whilst the guard is open. If after pressing the Stop button either contactor K1 or K2 stays closed the machine will stop but the solenoid cannot be energized or the guard opened.

LED 1 provides visual indication of solenoid power applied.

LED 2 provides visual indication of guard locked and machine able to start.

System is shown with machine stopped, guard closed and locked, and the solenoid able to be energized (Lock released).

Quick Connect (QC) M23 12 way Male Plug (Pin view from switch)	Switch Circuit
1 3	A1 A2
4 6	11 / 12
7 8	21 / 22
2 5	43 / 44
9	33
10	34
Earth	12

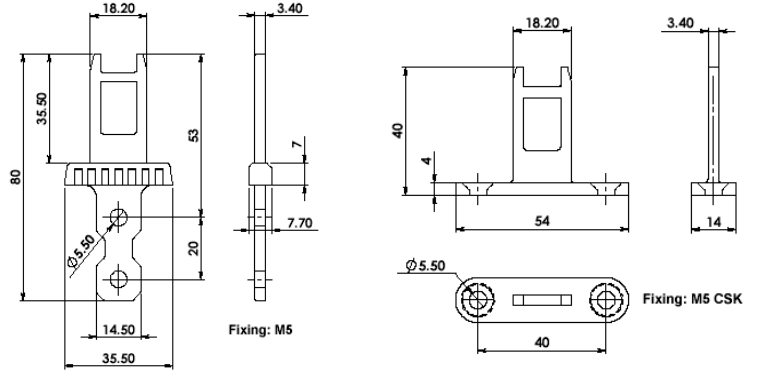
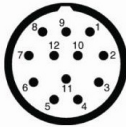

Actuator insertion (mm)

	6.0	5.0	0 mm
11/12	Open		
21/22	Open		
33/34		Open	
43/44			Open

The NC circuits are closed when the guard is closed and the actuator is present.

All NC contacts are positively operated at withdrawal of actuator

- Conforming to Standard:** ISO14119, IEC60947-5-1, UL60947-5-1, ISO13849-1
- Safety Classification and Reliability Data:**
- Mechanical Reliability B10d
  - ISO 13849-1
  - EN 62061
  - Safety Data - Annual Usage
- Solenoid Voltage (by part number)
- LED 2 Supply Voltage
  - Safety Contacts 11/12 21/22
- Overload protection fuse (fuse externally)
- Auxiliary Contact 33/34 (selectable with LED2)
  - Auxiliary Contact 43/44
  - Rated Insulation Voltage
  - Rated Impulse Withstand Volt
  - Travel for Positive Opening
  - Approach Speed
  - Man. Actuation Frequency
  - Actuator entry minimum radius
  - Case Material
  - Head Material
  - Actuator Material
  - Enclosure Protection
  - Operating Temperature
  - Holding Force
  - Vibration
- Conduit Entry
- Fixing

Information with regard to UL standards: Type 1 enclosure.  
Maximum temperature 40°C.  
Use 16-28AWG stranded copper conductors (rated 90°C).  
Terminal Torque 6 lb ins. (0.7Nm).  
Intended for same polarity use. A300 Pilot Duty. 240V. 3A.  
PF 0.38 or greater, tested for 6,000 cycles endurance  
Use one polymeric conduit connection.  
Not suitable for connection to rigid metal conduit.



**WARNING: DO NOT DEFEAT, TAMPER, OR BYPASS THE SAFETY FUNCTION. FAILURE TO DO SO CAN RESULT IN DEATH OR SERIOUS INJURY.**

**AVERTISSEMENT: NE PAS DESACTIVER, MODIFIER, RETIRER, OU CONTOURNER CETI INTERVERROUILLAGE IL PEUT EN RESULTER DES BLESSURES GRAVES DU PERSONNEL UTILISATEUR.**

## Original Instructions.

To request this data sheet in other languages please contact [info@idemsafety.com](mailto:info@idemsafety.com)  
Um dieses Datenblatt in Deutscher Sprache wenden Sie sich bitte anfordern [info@idemsafety.com](mailto:info@idemsafety.com)  
Pour obtenir cette fiche en Français, veuillez contacter [info@idemsafety.com](mailto:info@idemsafety.com)  
Para solicitar esta hoja de datos en Español, por favor contacto con [info@idemsafety.com](mailto:info@idemsafety.com)